

INDUSTRIAL TRIM

Custom Lengths up to 20' - 03" Available

Product	Gauge	Unit of Measure	Length	Weight	Part Number		Profiles & Dimensions
					Bare	Painted	
	26	LF	LF	.37	98701	98543	
	26	EACH	10'-3"	3.80	98700	98542	
	26	EACH	14'-3"	5.32	98738	98300	
Simple Base Trim							
	26	LF	LF	.56	98705	98546	
	26	EACH	10'-3"	5.80	98704	98545	
	26	EACH	14'-3"	8.12	98703	98304	
Base Trim							
	26	LF	LF	.70	98510	98511	
	26	EACH	10'-3"	7.15	98698	98509	
	26	EACH	14'-3"	10.0	98504	98505	
Masonry Wainscoat							
	26	LF	LF	.93	98609	98415	
	26	EACH	10'-3"	9.50	98608	98412	
	26	EACH	14'-3"	13.25	98606	98411	
Outside Corner							
	26	LF	LF	.93	98603	98407	
	26	EACH	10'-3"	9.50	98602	98405	
	26	EACH	14'-3"	12.25	98600	98402	
Inside Corner							
	26	LF	LF	.45	98709	98527	
	26	EACH	10'-3"	4.65	98708	98525	
	26	EACH	14'-3"	6.58	98744	98402	
Outside Angle Trim							

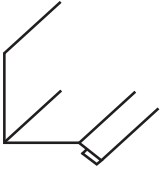

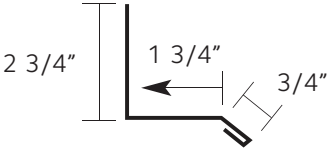
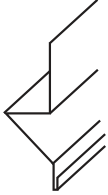
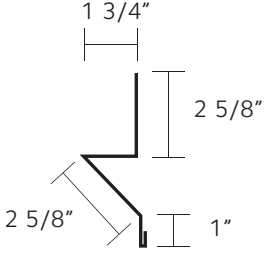
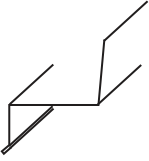
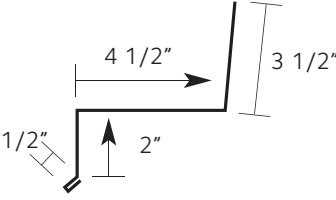
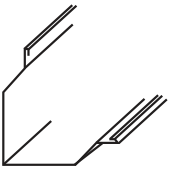
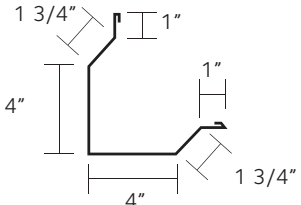
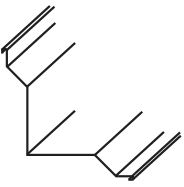
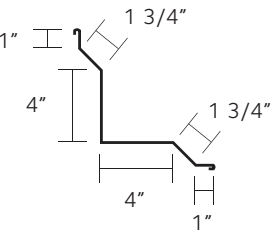
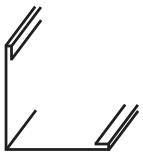
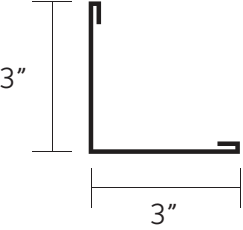

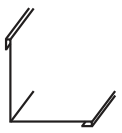
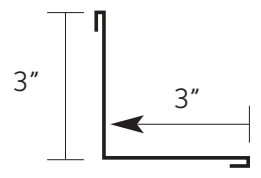
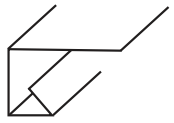
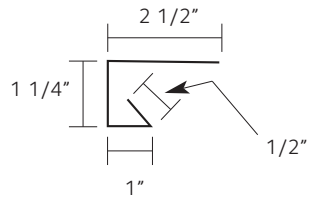
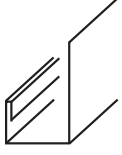
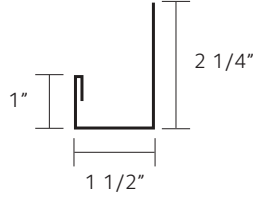
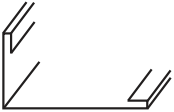
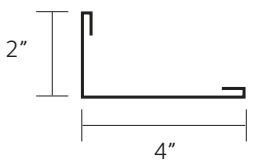
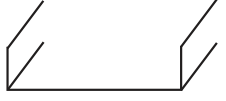
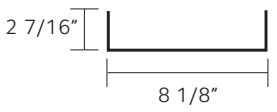
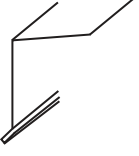
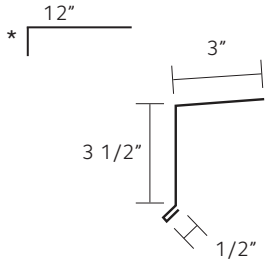
INDUSTRIAL TRIM

Custom Lengths up to 20' - 03" Available

Product	Gauge	Unit of Measure	Length	Weight	Part Number		Profiles & Dimensions
					Bare	Painted	
	26	LF	LF	.45	98707	98523	
	26	EACH	10'-3"	4.65	98706	98521	
	26	EACH	14'-3"	6.58	98742	98519	
Inside Angle Trim							
	26	LF	LF	.35	98685	98583	
	26	EACH	10'-3"	3.60	98682	98581	
	26	EACH	14'-3"	5.00	98678	98486	
Jamb Trim							
	26	LF	LF	.35	98675	98576	
	26	EACH	10'-3"	3.60	98668	98572	
	26	EACH	14'-3"	5.0	98664	98570	
Head Trim							
	26	LF	LF	.48	98729	98594	
	26	EACH	7'-1"	9.50	98728	98593	
	26	EACH	8'-1"	13.25	98730	98592	
	26	EACH	9'-1"	13.25	98731	98591	
Mini Jamb-Header Cover							
	26	LF	LF	.82	98723	98589	
	26	EACH	10'-3"	8.40	98722	98588	
	26	EACH	14'-3"	11.75	98718	98586	
Jamb-Header Cover							
	26	LF	LF	.51	98689	98541	
	26	EACH	10'-3"	5.25	98688	98540	
	26	EACH	14'-3"	7.42	98687	98308	
Eave Trim* *specify desired pitch							

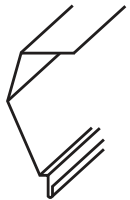
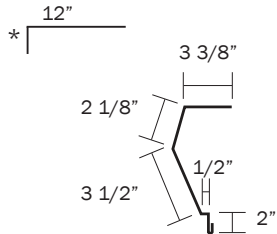
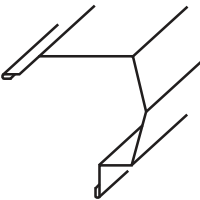
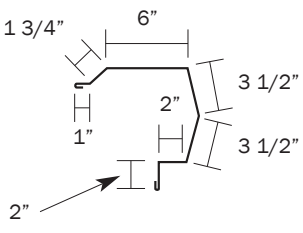
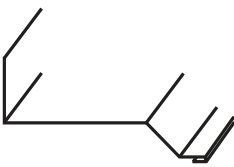
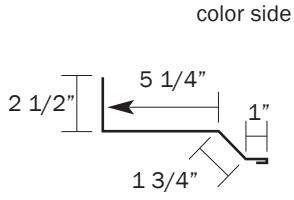
INDUSTRIAL TRIM

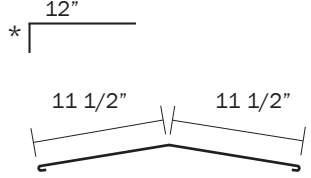
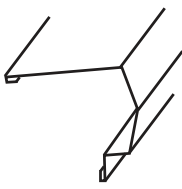
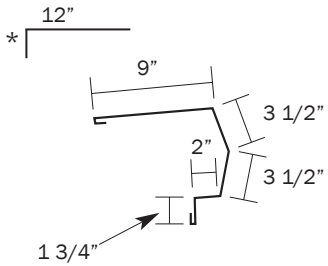
Custom Lengths up to 20' - 03" Available

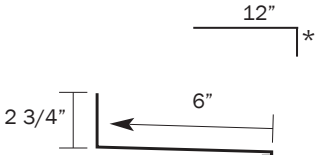
Product	Gauge	Unit of Measure	Length	Weight	Part Number		Profiles & Dimensions
					Bare	Painted	
 <p>Sculptured Eave Trim* *specify desired pitch</p>	26	LF	LF	.78	98736	98537	
	26	EACH	10'-3"	7.95	98734	98535	
	26	EACH	14'-3"	13.04	98733	98534	
 <p>Rake Trim</p>	26	LF	LF	1.34	98661	98477	
	26	EACH	10'-3"	13.75	98660	98475	
	26	EACH	14'-3"	19.32	98659	98474	
	26	EACH	20'-3"	27.15	98658	98473	
 <p>Rake Tie-In Trim</p>	26	LF	LF	.68	98691	98499	<p>color side</p> 
	26	EACH	10'-3"	7.00	98690	98497	
	26	EACH	14'-3"	9.80	98740	98495	
 <p>Ridge Cap* *specify desired pitch</p>	26	LF	LF	1.55	98619	98554	
	26	EACH	10'-3"	15.90	98618	98553	
	26	EACH	14'-3"	22.26	98717	98316	
 <p>High Side Eave Flashing* *specify desired pitch</p>	26	LF	LF	1.35	98715	98550	
	26	EACH	10'-3"	13.85	98714	98549	
	26	EACH	14'-3"	19.46	98713	98312	
	26	EACH	20'-3"	27.35	98712	98548	
 <p>High Side Tie-In Trim* *specify desired pitch</p>	26	LF	LF	.58	98693	98503	
	26	EACH	10'-3"	5.90	98692	98501	
	26	EACH	14'-3"	8.26	98746	98502	



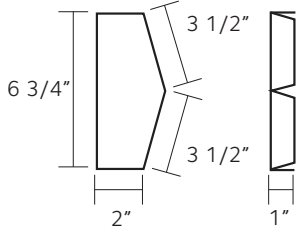
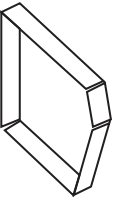
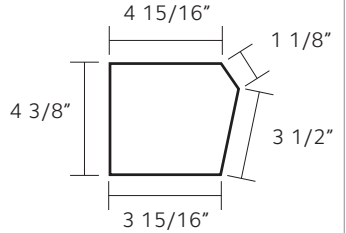
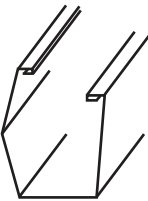
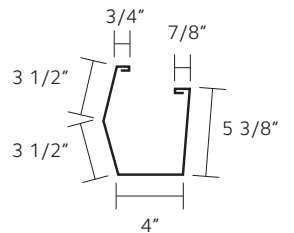
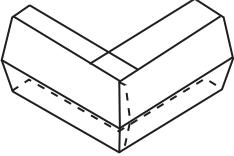
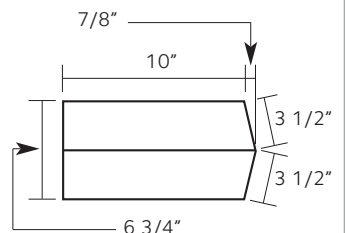
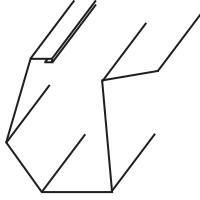
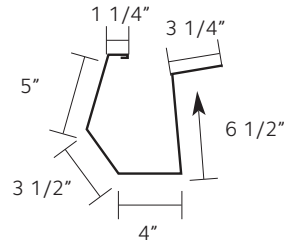
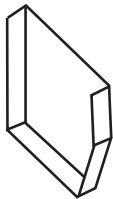
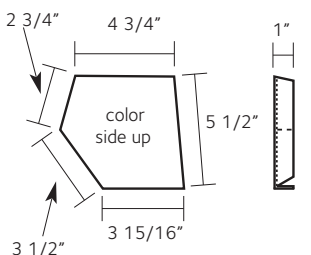

INDUSTRIAL TRIM

Custom Lengths up to 20' - 03" Available

Product	Gauge	Unit of Measure	Length	Weight	Part Number		Profiles & Dimensions
					Bare	Painted	
 <p>Rake Closure</p>	26	LF	LF	.35	98662	98479	
 <p>Standard Gutter End Cap (Right Hand Shown Left Hand Opposite)</p>	26	LF	LF	.30	98628	98441	
 <p>Standard Gutter</p>	26	LF	LF	1.19	98623	98390	
	26	EACH	10'-3"	7.00	98622	98491	
	26	EACH	14'-3"	9.80	98621	98392	
	26	EACH	14'-3"	9.80	98620	98393	
 <p>For Standard Gutter (Right Hand Shown Left Hand Opposite)</p>	26	LF	LF	2.30	98610	98417	
 <p>Sculptured Gutter</p>	26	LF	LF	1.58	98627	98439	
	26	EACH	10'-3"	16.20	99843	98437	
	26	EACH	14'-3"	22.68	98625	98436	
	26	EACH	20'-3"	32.00	98624	98435	
 <p>Gutter End Cap Sculptured (Right Hand Shown Left Hand Opposite)</p>	26	LF	LF	.30	98630	98443	

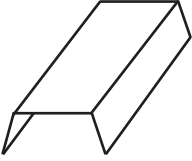
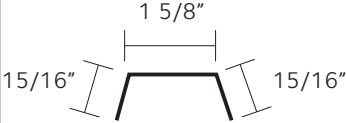
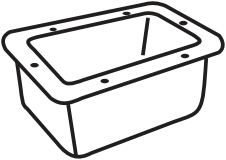
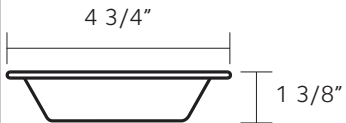
INDUSTRIAL TRIM

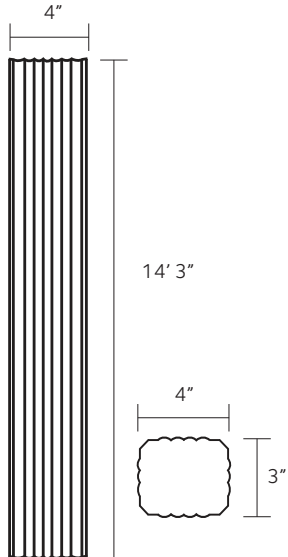
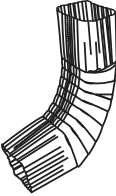
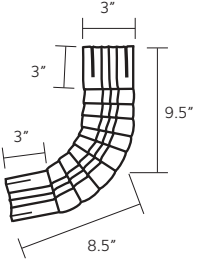
Custom Lengths up to 20' - 03" Available

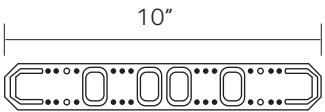
Product	Gauge	Unit of Measure	Length	Weight	Part Number		Profiles & Dimensions
					Bare	Painted	
	26	EACH	0'-6"	.18	98632	98445	
Gutter Strap							
	26	EACH	LF	1.34	98661	98477	
Aluminum Downspout Outlet Box							
	26	LF	14'-3"	.68	90442	90410	
3" x 4" Downspout							
	26	EACH	NA	.50	90435	90520	
3" X 4" Downspout Elbow A-Style							
	26	EACH	10"	.04	90467	90397	
Downspout Strap							

INDUSTRIAL TRIM

Custom Lengths up to 20' - 03" Available

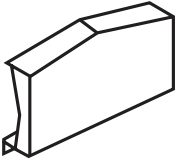
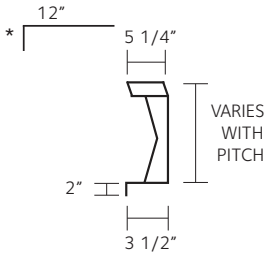
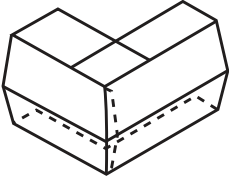
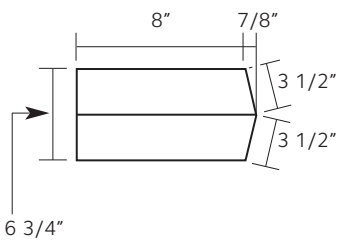
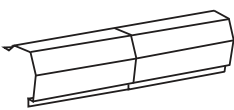
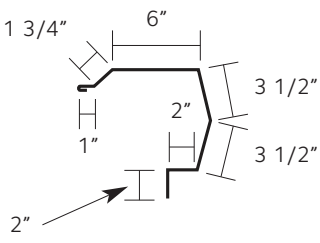
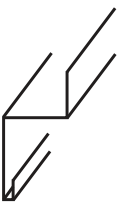
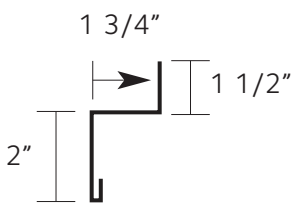
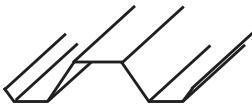
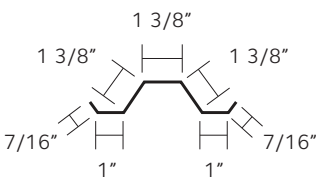
Product	Gauge	Unit of Measure	Length	Weight	Part Number		Profiles & Dimensions
					Bare	Painted	
 <p>Fixed Peak Box* *specify desired pitch</p>	26	EACH	1'-8"	2.40	98614	98421	
 <p>High Side Corner Box (Right Hand Shown Left Hand Opposite)</p>	26	EACH	NA	2.30	98615	98425	
 <p>Variable Peak Box</p>	26	EACH	4'-0"	5.40	98612	98419	
 <p>Zee Flashing</p>	26	LF	LF	.37	98711	98531	
	26	EACH	10'-3"	3.80	98710	98529	
	26	EACH	14'-3"	5.32	98720	98528	
 <p>Skylight Side Trim-UL90</p>	26	LF	LF	.44	98773	98766	
	26	EACH	10'-3"	4.55	98730	98765	